

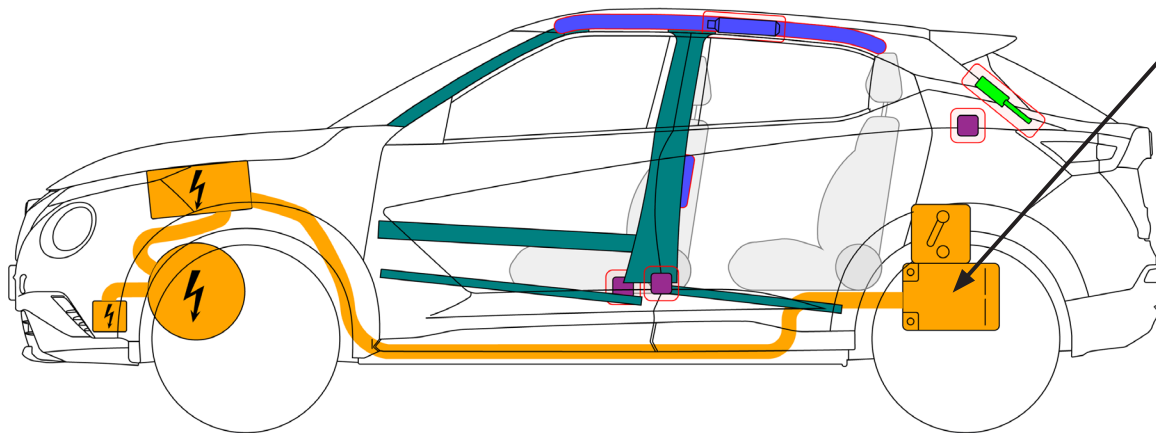

Nissan
Juke Hybrid
 Type: F16, 5-door SUV
 (2022 -)

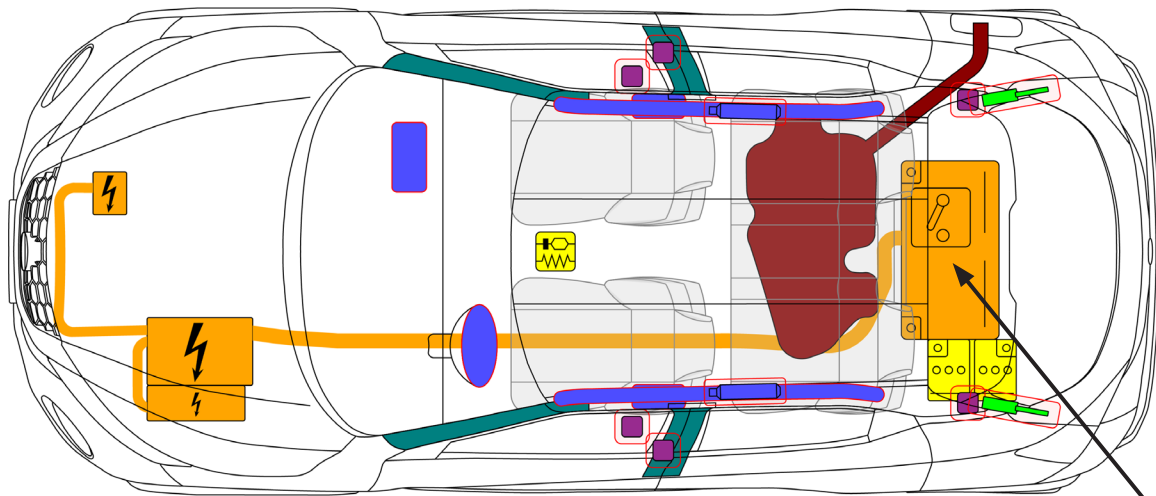
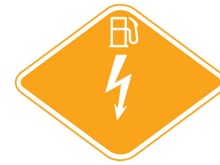

**286 V
Li-ion**

Airbag	Hogedruk gasgenerator	Gordelspanner	SRS-regeleenheid	Accu, laagspanning
Gasdrukveer / voor-gespannen veer	Zone met versteviging	Hoogvoltage apparaat dat hoogvoltage uitschakelt	Hoogspanningscomponent	Accu, hoogspanning
Hoogspanningskabel	Inhoud brandstoftank benzine / ethanol			

1. Identificatie / herkenning



HET ONTBREKEN VAN MOTORGELUID BETEKENT NIET DAT HET VOERTUIG UIT IS. STILLE BEWEGING IS MOGELIJK TOTDAT HET VOERTUIG COMPLEET IS UITGESCHAKELD. DRAAG ALTIJD PASSENDE PERSOONLIJKE VEILIGHEIDSUITRUSTING. DRAAG ALTIJD PASSENDE PERSOONLIJKE VEILIGHEIDSUITRUSTING.

Merklogo



Modelnaam



2. Immobilisatie / stabilisatie / heffen

Voertuig immobiliseren:

1. Blokkeer de wielen en bedien de handrem door aan de hendel te trekken



Hefpunten:

 Geschikte hefpunten

 Hoog voltage accu

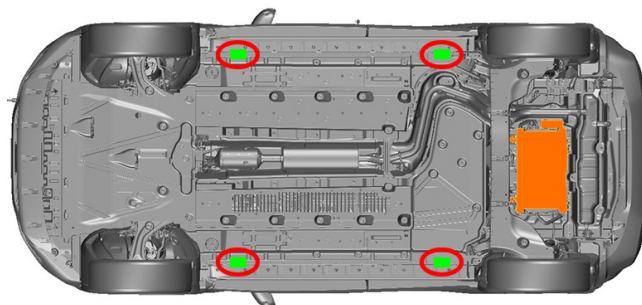

3. Directe gevaren uitschakelen / veiligheidsvoorschriften



Na een ongeval met over de kop slaan en/of airbag activering, zal het aandrijfsysteem worden uitgeschakeld. Het airbagsysteem is nog steeds actief.

1. Druk eenmaal op de Start/Stop knop wanneer de "Ready" indicator in het instrumenten paneel oplicht

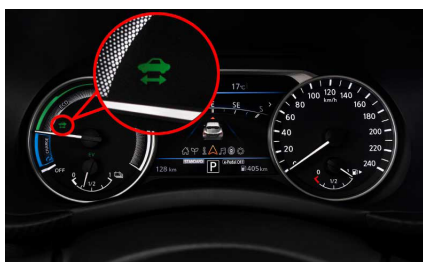

Verwijder de elektronische sleutel en houd deze tenminste 16 ft. (5 m) bij het voertuig vandaan

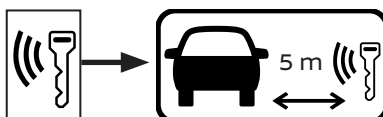

Toegang tot de kofferbak



2. Ontkoppelen van de 12V-accu

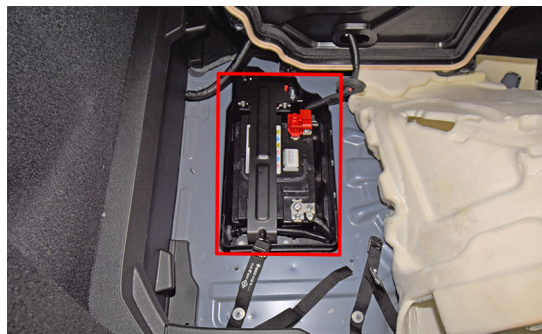
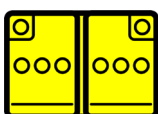

3. Deactivering van hoogspanningssysteem, gebruik klasse 0 rubberen isolerende handschoenen bij gebruik van de ontkoppelingsschakelaar.

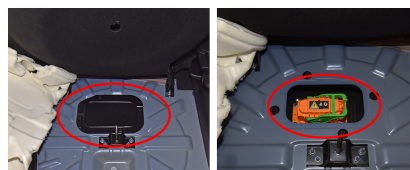

Veiligheidsvoorschriften:

Nooit een oranje hoogspanningskabel of hoogspanningscomponent openen, knippen of aanraken!

4. Toegang tot de inzittenden

Hoge sterkte staal in carrosserie en deur

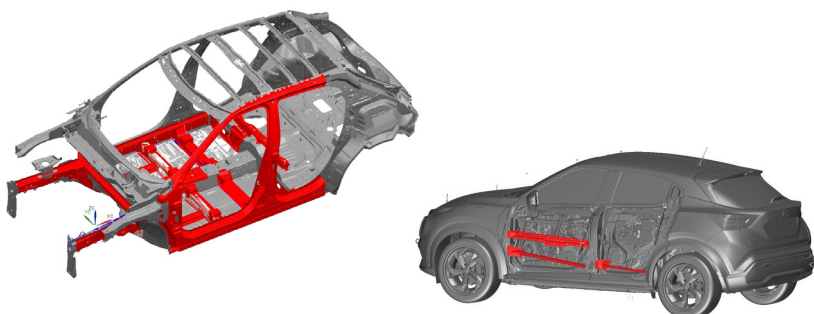

Stuurkolom verstelling



Nissan Juke HEV Type: F16, 5dr SUV (2022 -) – Extra Pagina's

Stoel verstelling

















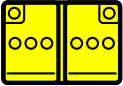

Raamsoorten:

- A. Gelaagd glas
- B. Gehard glas



5. Opgeslagen energie / vloeistoffen / gassen / vaste stoffen

	Lithium-ion 150-286V						
	12V						
	R-1234yf 500 25 g						
	46L						



Als koelvloeistof uit het accupakket lekt, kan deze onstabiel worden met het risico op een Thermal Runaway. Een stijgende temperatuur van het accupakket kan duiden op een Thermal Runaway.

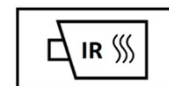

6. In geval van brand



GEBRUIK GROTE HOEVEELHEDEN PUUR WATER



POTENTIEEL RISICO OP HERSTARTEN VAN BRAND OF VERLATE ONTSTEKING!

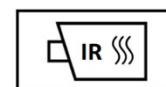

Hulpverleners moeten zichzelf altijd beschermen met persoonlijke beschermingsmiddelen (PBM) inclusief onafhankelijke adembescherming en adequate veiligheidsmaatregelen nemen om burgers die zich benedenwinds van het incident bevinden, te beschermen.



GASVEER, RISICO VAN RAKETEFFECT



7. In geval van onderdompeling

- Er is geen verhoogd risico op elektrische schokken in water als gevolg van het hoogspanningssysteem;
- Haal het voertuig indien mogelijk uit het water en ga verder met de deactiveringsprocedure voor dit voertuig (zie hoofdstuk 3).

8. Slepen / transport / opslag

Locatie trekhoog



Locatie sleepoog voor



Locatie sleepoog achter



Slepen



PARKEER HET VOERTUIG IN DE OPENLUCHT OP VEILIGE AFSTAND \geq 5 M VAN ANDERE OBJECTEN OF VOERTUIGEN!

POTENTIEEL RISICO OP HERSTARTEN VAN BRAND OF VERLATE ONTSTEKING!

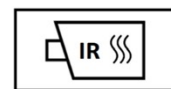

10. Verklaring van gebruikte pictogrammen

	Slimme sleutel verwijderen		Hybride elektrisch voertuig op brandstof van vloeistofgroep 2
	Waarschuwing, elektriciteit		Ontvlambaar
	Algemeen waarschuwingsbord		Gevaar voor de menselijke gezondheid
	Waarschuwing; lage temperatuur		Acute toxiciteit
	Airco-component		Explosief
	Gebruik water om het vuur te blussen		Corrosief
	Gebruik thermische infraroodcamera		Achterbak